



Automation Technology

Comparative Seminar

Smart Consultant

Automation

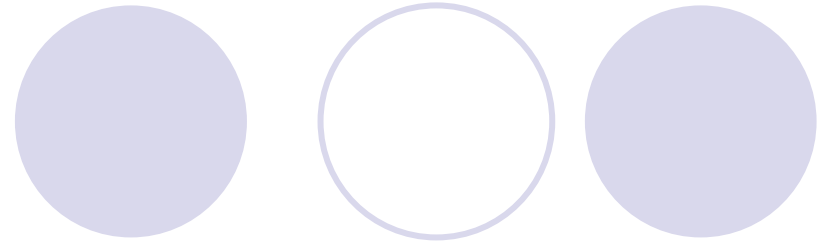

- It is the Ability to:

- Communicate
- Interrogate status
- Control
- And Integrate

- Is Three Levels:

- Centrally Monitoring
- Centrally Controlling
- Logically Controlling and Monitoring

Needs of the Automation Process:

● Inputs

- Sensors (Temp, Humidity, Motion, LUX, Mags ++)
- Human Interfaced commands
- Timers
- Events

● Outputs

- Actions queue
- Sounds and Lights
- Motorized control

Automation Is Simple

Keep it Simple

Easy To Install

Minimum Wiring

Flexible Voltage

Easy To Expand

Easy To Use

Elegant Suite

Affordable

Distributed Intelligence

Commonality between Green and Smart

- **Energy Saving** (Cut Down the Wastage)
- **Materials Saving** (Less conduits and Wires)
- **Time Saving** (Faster Installation and Maintenance)
- **Healthier Life Practice** (Air and Water Quality)
- **Less Replacement Maint.** (Longer Usability)
- **Less Pollution** (Noise/ Dust)
- **Better Environment**
 - **Is Smart-BUS a Green BUS?**

Available Best famous World's Brands

- Crestron and **AMX** (Control)
- Clipsal, **Lutron**, Dynalite & **ABB** (Lighting)
- **HAI** and Cytech (Security)
- Elan, Opus, **Nuvo** (Distributed Audio)
- Media Max, **Kaleidescape** (Video)
- Somfy, **Silent Gliss** (Shades Motors)
- Jung, **Control4** (Wireless Tech)
- Legrand, **Gira** (Elegant Glass Outlets)

Current Automation Wiring

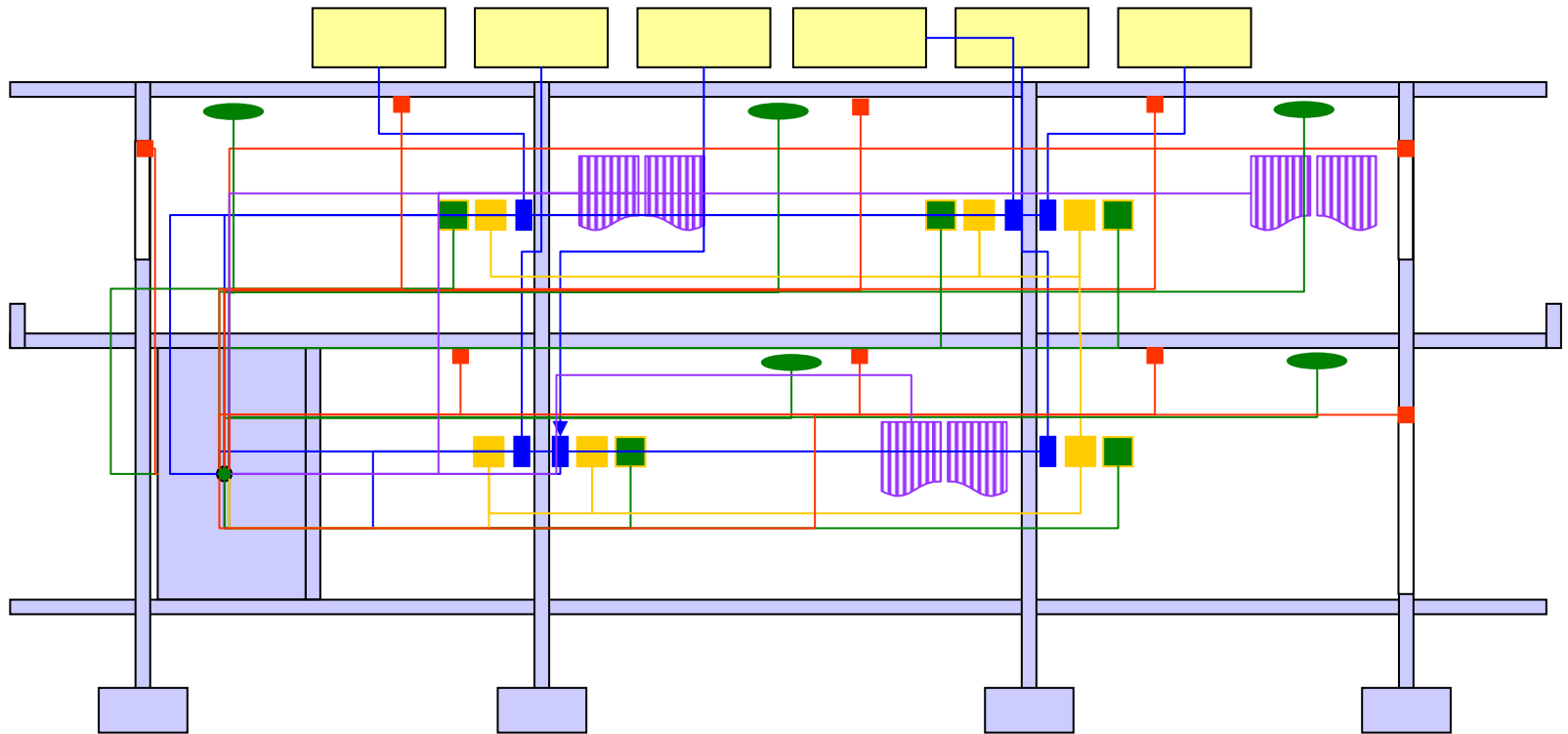

- Security: Addressable Zone to Controller at smart Room
- AC: Compressor to Thermostat to Control at smart Room
- Lighting: Switch to switch to Lighting DB / Controller at smart Room
- Audio Dist: Speaker To Amplifier, Pad to Matrix Controller
- Curtain Motor: to Controller to Smart Room

S-BUS Wiring

(Example)

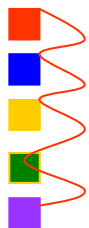
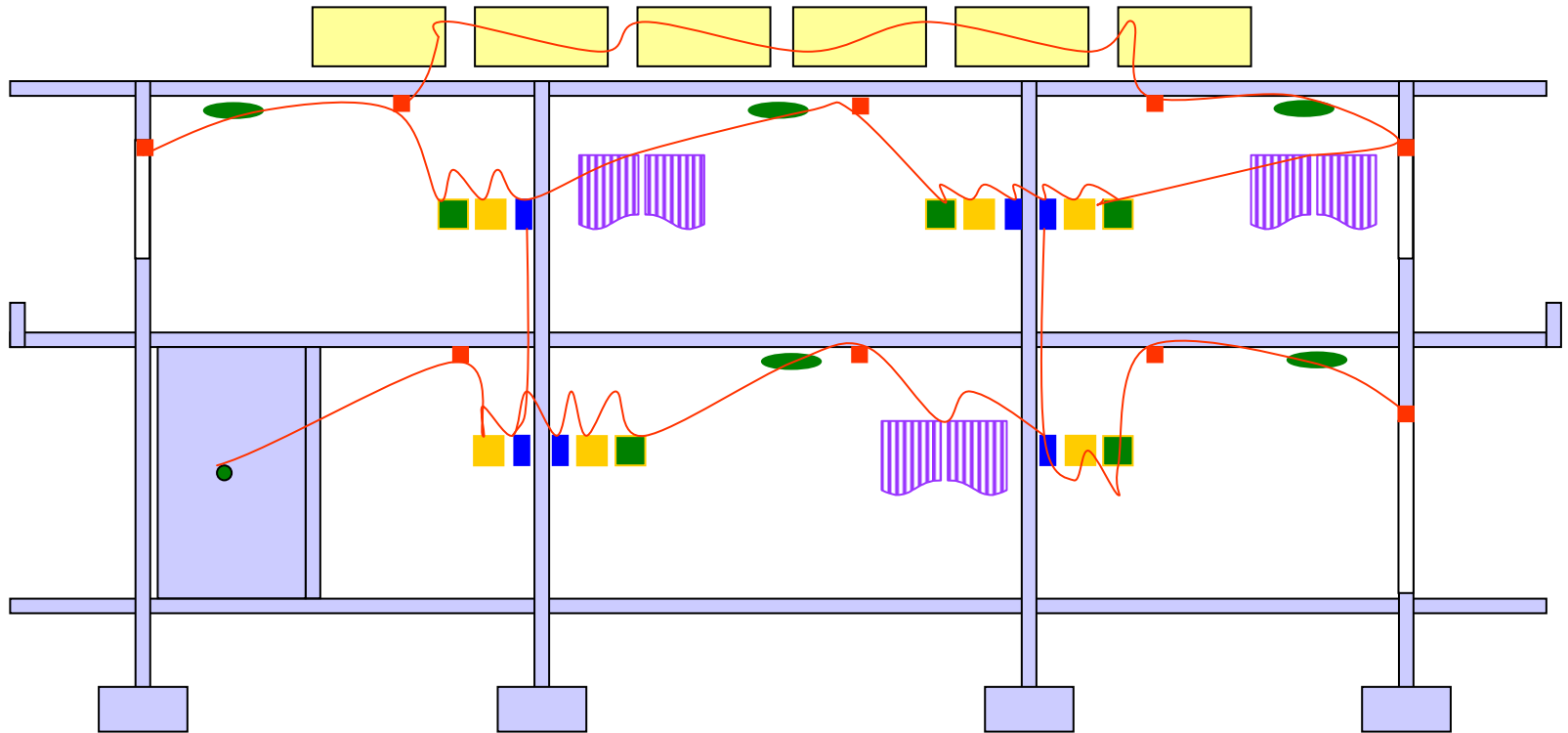

To Nearest, loop, Star or Mesh



Simple Tools



Simple Job

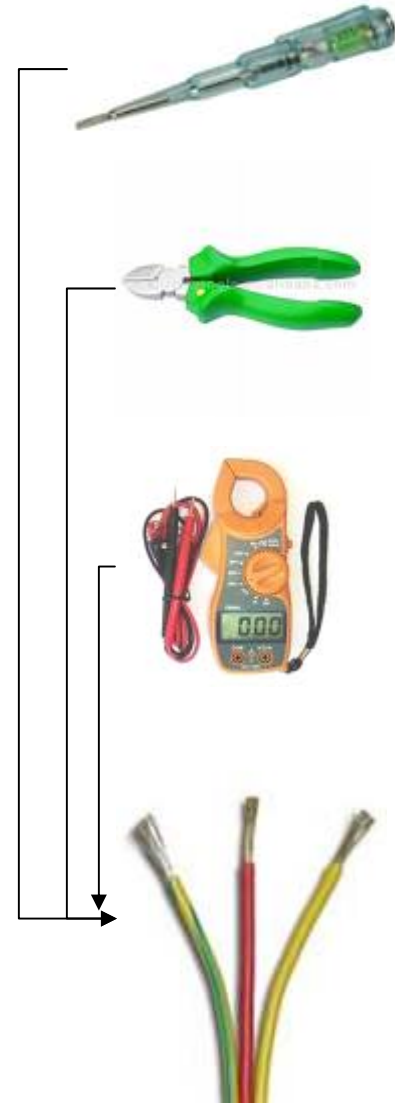

Comparisons (Villa)

(Solutions)

Famous World's Brands Offered Main Solutions: [\(integration and Macros\)](#)

Crestron and **AMX** (Touch screens, Lighting, Interface Controller, IR Net) **(7 Days-S)**

Dynalite, **Lutron** & **ABB** (Lighting, Dimming, Double Throw, Switches, HVAC, Occupancy) **(3 Days)**

HAI and **Cytech** (Security, Thermostats) **(1 Day)**

Sonos, **Opus**, **Nuvo** (Distributed Audio, Matrix, Amplifiers, Volume Pads) **(1 Hour)**

Media Max, **Kaleidescape** (Video Distribution) **(3 Days)**

Somfy, **Silent Gliss** (Shades Motors) **(1 Day)**

Jung, **Control4** (Wireless Tech, Zigbee) **(1 Day)**

Legrand, **Gira** (Elegant Glass Outlets, Sockets, Switches)

ADB, **Strand**, **ETC** (DMX, LED Drivers and Stage Lighting) **(1 Hour)**

Honeywell, **Siemens**, **Beckhoff** (BMS, GRMS)



Smart-HDL BUS (All Above Solutions and Some More) **(1 Day)**

Then User Can Do it Himself

Comparisons

(Technology)

World's Famous Brands	Smart-HDL 
Mostly Need Special Expensive Wire Types	Use any Wires, Short Cuts OK
Max 1.1 KM Distance with best wires	Max 1.6 KM Distance
Can Connect 128 Devices Max on 1 Loop and some can reach 65000 in Total	Can Connect 65000 Devices Max on 1 Loop, and 16500000 in total
Need to Integrate to Many Other systems to Complete Solution Needs	Single Technology Solve all
Not Fully 2-way	Fully 2-way technology
Require Spaghetti Wiring	Simple single or Double wires only
One Brain	All Brains
Not Fully Logical, Sometimes Central	Fully Logical and Smart
Limited Functions and Speed	Unlimited Functions and Speed
Need Professional Installers and Scripting	Any Electrician can Install and Run system
Very Expensive	Very Affordable
Simple Protection	Full Protection (Overheat, Over Load, Surge, Reverse Polarity, Tolerance)

Smart-HDL S-BUS

(Solutions)

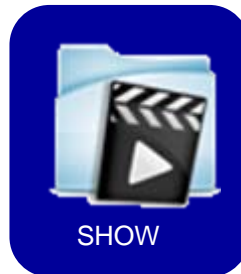
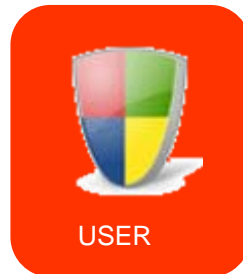
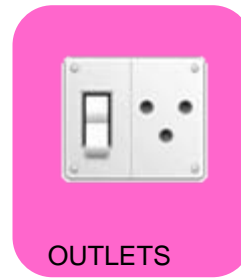
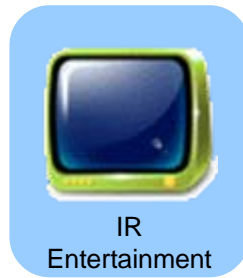
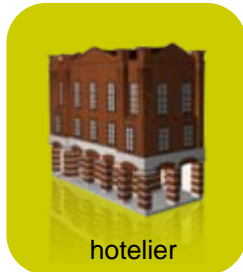
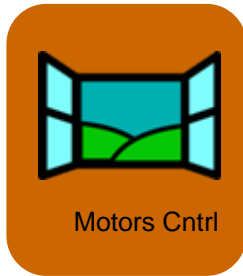

Lighting



Up To 40,000 Channels in One Network



Colors

- LED
- DMX Color Wheel
- DMX512

Shape, Speed

Dimming

- Halogen
- Incandescent
- Florescent
- Cold Cathode
- LED

ON/Off

- All Types



Solutions

HVAC



Up To 30,000 HVAC Units in One Network

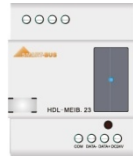

Split AC

-IR Control



VAV/VRV

-0-10 V

-0-15 V

-Lon Works/Mnet

-MOD-BUS

-RS-232/485



FCU/AHU

-Cold Unit 1

-FAN Speed

-HOT

-Cold Unit 2

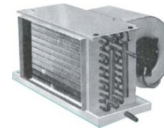

ON/Off

-Window AC

-Desert Cooler

-Exhaust Fans

-Fresh Air



Solutions

Security



Up To 250,000 Security and Safety Zones and Groups



Safety

- Smoke/Heat
- Gas Leak
- Pool Guard
- Elevator Alert
- Baby Monitor

Security

- Door Window
- Motion PIR
- Ultrasonic
- Microwave
- SMS Dialer

Access

- Apartment Entry
- Door Access Code
- BioX
- Long Range RFID

CCTV

- Intercom
- Cameras
- DVR
- PTZ



Solutions

Audio



Over 1470 Zones in One Network

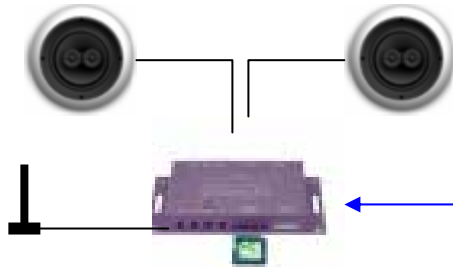

Relegious

- Prayer Athan
- Quraan
- Angelinos



Music/PA

- Radio
- SD Card Play List
- TV Connection
- PA Announcement

Alerts

- Alarms
- Reminders
- Text to Speech



Solutions

Motorization

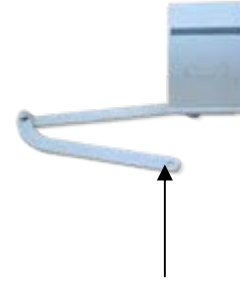
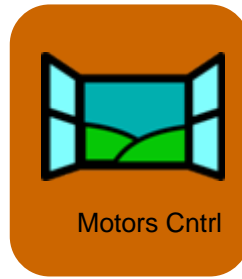

Lifts

- Plasma Lift
- Projector Lift
- Motorized Screen
- Pool Floor Lifts
- 350 Deg. Rotators

GATES

- Swing/Slide Gates
- Garage Shutter
- Patio Doors

SHADES

- Curtains
- Drapes
- Blinds
- Sky Lights



Solutions

Energy



5A to 20000A Per Channel

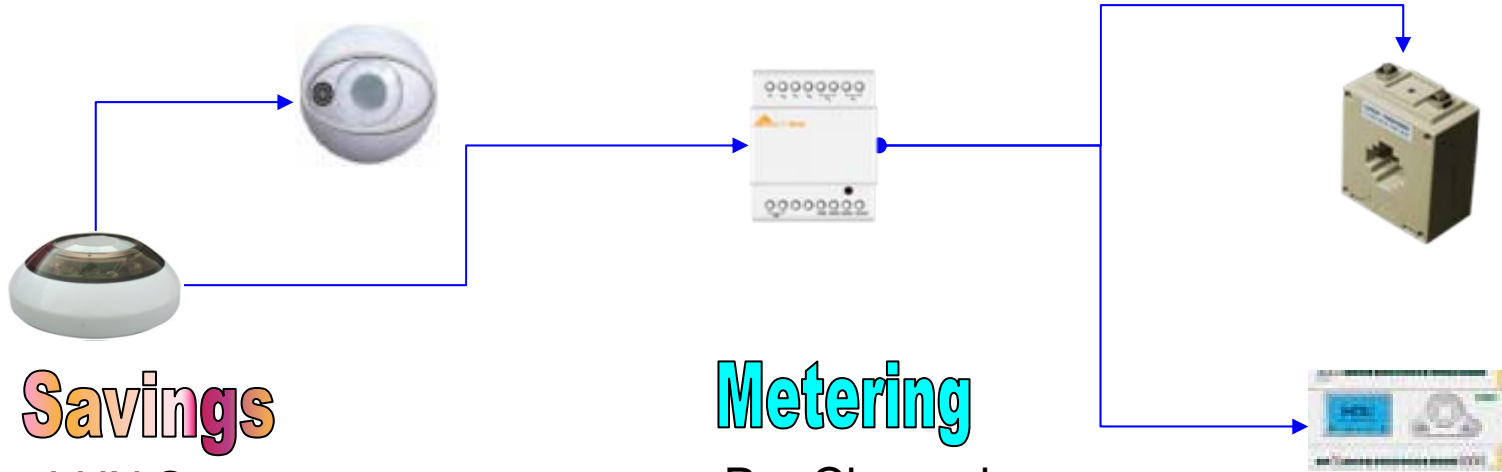

Savings

- LUX Sensor
- Occupancy
- Infiltration
- Timers
- SMS Alerts

Metering

- Per Channel
- Per Group/Floor
- Per hour
- Per Day/Week
- Per Month



Solutions

BMS



Up To 56,000 Ports in One Network

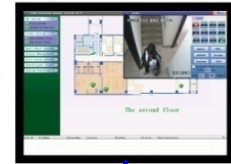
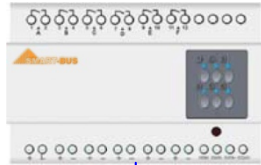

DIGITAL

- Discreet Inputs
- Discreet Outputs
- Digital Pulsing I/O



ANALOGUE

- 0-5Volts I/O
- 0-10Volts I/O
- 1-15Volts I/O
- 4-20mA I/O
- 1000 Ohm



EMS/BMS

- Logic
- BMS SW
- Equipment Health SW
- Smart SMS



Solutions

Media

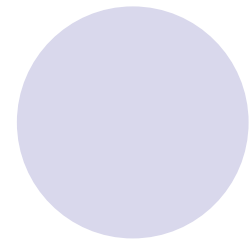
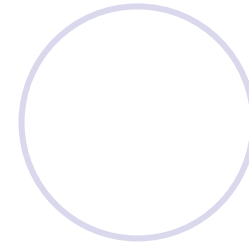
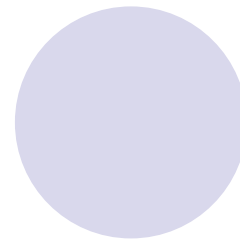

Monitored

- TV
- DVD
- Sat Decoder
- Media Projectors



Streamed

- On Screen Control
- Multi Room
- Play Pause, Queue
- Monitor
- Text to Screen
- Invite

Separated

- Split AC
- SMART TV
- Smart AV
- Shades
- Macros



Solutions

Hotelier

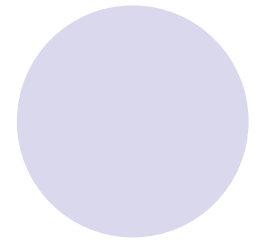
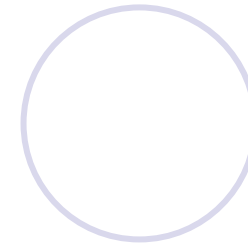
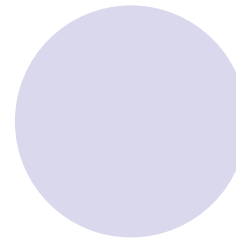
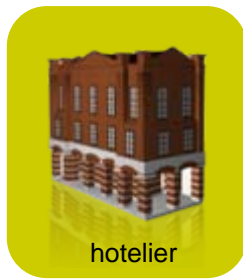

Door

- Door Bell
- Door Lock
- DND
- MUR
- Pick Laundry
- Room Number

BEDSide

- Lighting
- Service/DND
- HVAC
- Music
- Shades
- TV / MOD

Control

- Moods
- Master/Energy
- Shades
- Defoggers
- Exhaust Fan
- Sensors

Special

- Room Partitioner
- On Line Service
- EMS
- Media Streaming
- Languages
- Security



Solutions

Integration



More Than 200 RS-232/485 in One Network

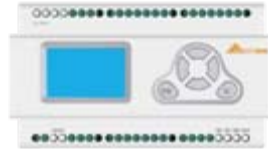

RS-232/485

- ASCII
- HEX DECIMAL

NET

- UDP
- TCP/IP
- H-NET
- Art-Net
- Mnet/Lonworks
- OPC/BACnet

BUS

- Smart-BUS
- EIB/KNX
- HDL-BUS
- MOD-BUS
- DMX/DMX512
- W-BUS

Other

- DALI
- Voltage
- NO/NC
- IR Commands
- RF



Solutions

Show

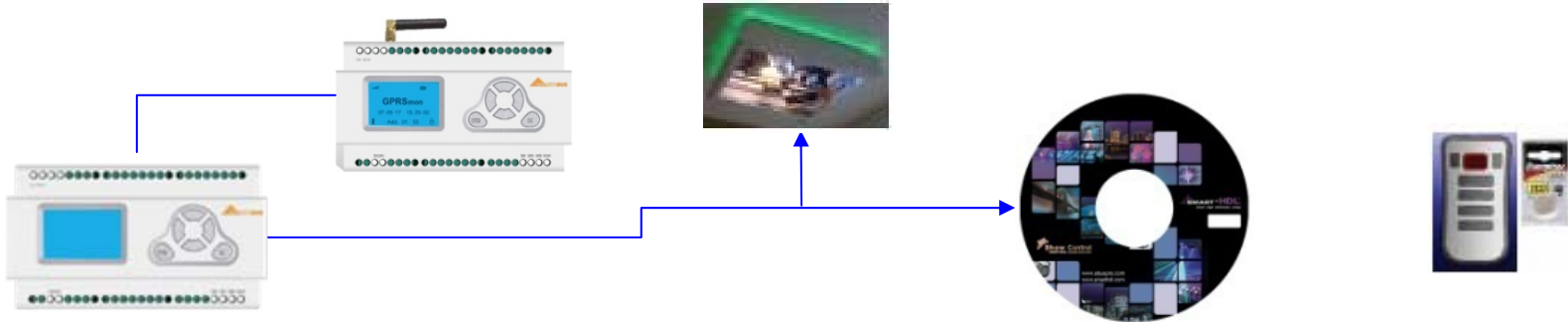
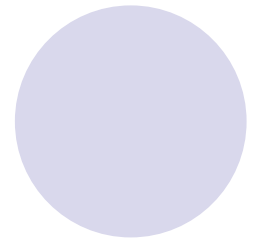
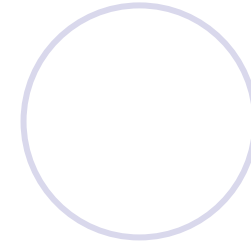
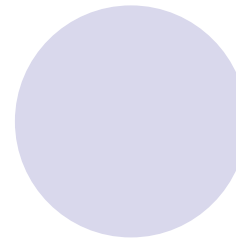

Ambiance

- Temperature
- Sound Level
- Audio Effects
- Fan Speeds

Lighting

- Color
- Intensity
- Patterns
- Shapes
- Speed

Effects

- Smoke
- Fire/Snow/Bubbles
- Pressure/Vibration
- Laser
- Smell

Play List

- Films
- Music
- Presentations
- Documents
- Flash media

Controls

- Fountains
- Pneumatics
- Motors
- Valves
- IR
- RS-232++



Solutions

User Panels

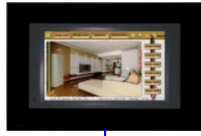
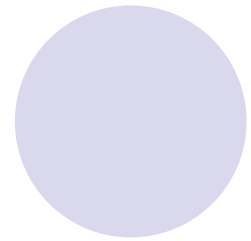
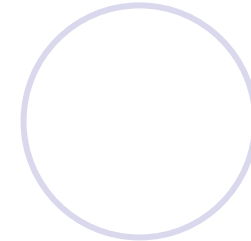
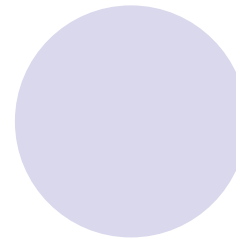

Touch Screen

- 7" Visual HDL
- 7" Touch Life
- 14" HAC
- 10" Wireless



Hand helds

- Remote control
- PDA Wifi
- Pronto Set



Switches

- 1G,2G,4G
- 3G, 6G
- DLP
- Touch Switch
- DLP+M

SMS/GPRS+

- SMS
- WIFI Tablets
- Laptop
- Any PC
- HAL2000 Voice+ Web



Solutions

Wire-line

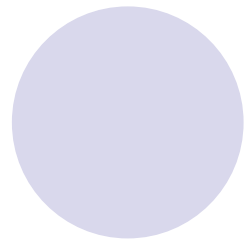
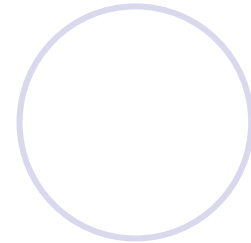
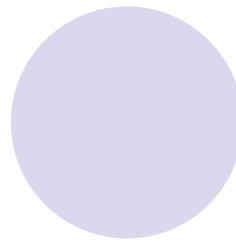
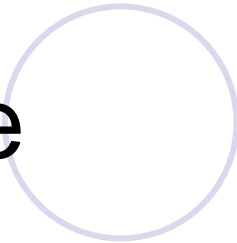

Switches

Sockets

Outlets

Special

- 1Gang, 2Gang
- 3Gang, 4Gang
- Door Bell
- Dimmer 1G
- Timer Touch

- European
- UK 3 Pin
- USA/Australia
- Universal
- Switched

- Telephone
- DATA
- TV
- MOD
- VGA/ HDMI

- Shaver
- Microphone
- Speaker
- A/V
- USB Charger

Video Intercom, Gate Motors

Stand Alone Sensors++



Solutions

Our Promises

- Latest Advancement Technology
- Best Quality and Finishes
- Prompt Delivery and Support
- Best Prices Affordability
- Full Solution Compatibility
- Huge Worldwide Network
- Admirable Track records

Awards

- Best Integrated Home System 2010
- Best Intelligent Lighting Middle East
- Best Green Building Product Technology



TechHome[®]



Mark of Excellence

Awards



Keep Old Budget Intact

Only By Using Normal Assigned BUDGET of:

- (Normal Standard Lighting and Switches)
- (Normal Security Burglar Alarm System)
- (Normal HVAC Thermostats)
- (Timers)

We Help Make the Building Smart in order to gain:

- 1- Up To Date Image and Reputation
- 2- Stand Away from your Competitors
- 3- Have Very Elegant System and Finishes
- 4- Save energy, Reduce Materials used,
- 5- Help Environment & Enhance Health
- 6- Full Flexibility To Expand building systems in Future.

**From \$900
to \$3000
Per 3BR Apt.
As Mass Dev.**